AMS READY

The Atlona AT-UHD-CAT-4 is a 4K/UHD HDMI to HDBaseT™ distribution amplifier featuring pass-through HDMI input connections, four HDBaseT outputs and display control capability. Each output transmits AV and control signals up to 230 ft. (70 m) @ 1080p and 130 ft. (40 m) @ 4K/UHD. Features include 4K/UHD @ 60 Hz with 4:2:0 color subsampling, HDCP 2.2 compliance, EDID management, and PoE for powering remote receivers. A wide variety of consumer and commercial displays may be controlled by the AT-UHD-CAT-4 using CEC, IR, or RS-232. Designed for commercial distribution applications, the AT-UHD-CAT-4 is control system-friendly and integrates with any TCP/IP, RS-232, or IR control system and features a 1U, half-rack width enclosure with external, international power supply. Compatible Atlona receiver: AT-UHD-EX-70C-RX.

Signal distribution applications increasingly require compatibility with HDCP 2.2, 4K/UHD @ 60 Hz support with 4:2:0 color subsampling to ensure images reach displays with compatible copy protection and with the pristine digital image quality of the original signal, without artifacts resulting from inferior image distribution systems. HDBaseT distribution ensures reliable, long-distance transmission of high resolution audio and video signals. These core features along with added display control provide additional flexibility. Power over Ethernet not only provides compatibility with Atlona Extender products but enables HDBaseT Certification.

Four HDBaseT outputs with transmission of AV and control signals and PoE -

- Long distance, 230 foot (70 m) outputs offer bidirectional extension of both RS-232 and IR control plus remote receiver power
Compatible Atlona receiver: AT-UHD-EX-70C-RX
- Reduces multiple, separate cable runs down to a single category cable per display, shrinking cable bundles and required conduit capacity to reduce cost of installation

Display control -

- CEC, IR or RS-232 control signals transmitted over HDBaseT
- Enables control of a wide variety of displays including commercial or low-cost consumer displays

HDMI distribution amplifier with built-in HDBaseT transmission -

- Combines signal distribution and long distance transmission into a single enclosure; eliminates several devices and power supplies
- Reduces overall system costs, speeds installation, and prevents compatibility issues

4K/UHD capability with HDCP 2.2 copy protection -

- Compatible with ultra-high definition sources and displays; adheres to latest content protection specification
- Ensures AV distribution systems are ready for 4K/UHD streaming services and playback devices

Specifications

Video Resolutions

Video	4096x2160@24/25/30/50*/60Hz*, 3840x2160@24/25/30/50*/60Hz* (UHD), 2048x1080p, 1080p@23.98/24/25/29.97/30/50/59.94/60Hz, 1080i@50/59.94/60Hz, 720p@50/59.94/60Hz, 576p, 576i, 480p, 480i	
VESA	2560x2048, 2560x1600, 2048x1536, 1920x1200, 1680x1050, 1600x1200, 1600x900, 1440x900, 1400x1050, 1366x768, 1360x768, 1280x1024, 1280x800, 1280x768, 1152x768, 1024x768, 800x600, 640x480	
Color Space	YUV, RGB	
Chroma Subsampling	4:4:4, 4:2:2, 4:2:0	
Color Depth	8-bit, 10-bit, 12-bit	

Audio

HDMI	PCM 2Ch, LPCM 5.1, LPCM 7.1, Dolby Digital, DTS 5.1, Dolby Digital Plus, Dolby TrueHD, DTS-HD Master Audio, Dolby Atmos, DTS:X	
Sample Rate	32kHz, 44.1kHz, 48kHz, 88.2kHz, 96kHz, 176.4kHz, 192kHz	
Bit Rate	up to 24-bit	

Distance

CAT5e/6 @ 4K	up to 35 meters	up to 115 feet
CAT6a/7 @ 4K	up to 40 meters	up to 130 feet
CAT5e/6 @ 1080p	up to 60 meters	up to 197 feet
CAT6a/7 @ 1080p	up to 70 meters	up to 230 feet
HDMI IN/OUT@ 4K	up to 5 meters	up to 15 feet
HDMI IN/OUT @ 1080p	up to 10 meters	up to 30 feet

Signal

Bandwidth	10.2 Gbps
CEC	Compliant
HDCP	Compliant 2.2

Temperature

Operating	0°C to 50°C	32°F to 122°F
Storage	-20°C to 60°C	-4°F to 140°F
Humidity	20 to 90% non-condensing	

Power

Consumption	52.8W
Idle Consumption	12.54W
Supply	Input: AC 100-240V ~ 50/60Hz Output: DC 48V/2.08A

Dimension

H x W x D	44 x 222.25 x 261 (mm)	1.73 x 8.75 x 10.28 (inch)
Rack Unit	1/2 rack, 1RU	

Weight

Device	1.66 kg	3.70 lbs
--------	---------	----------

Certification

Unit	CE, FCC
Power Supply	CE, FCC, Level VI, RoHS, cULus, RCM, CCC

*4096x2160@50/60Hz & 3840x2160@50/60Hz supported @ chroma subsampling 4:2:0 8-bit only

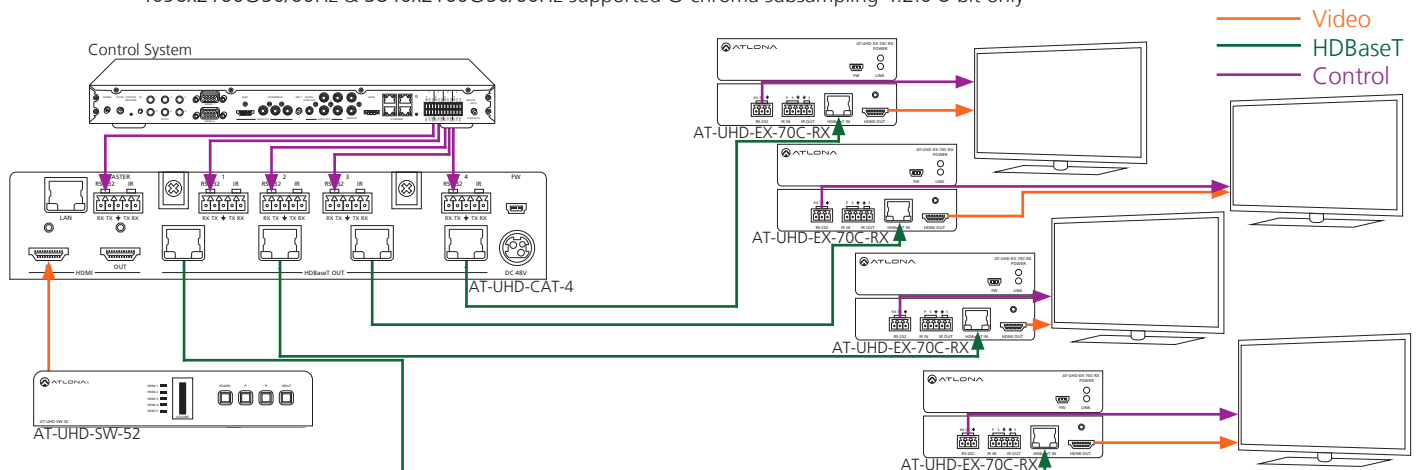

Specifications and availability subject to change without notice. Actual products, product images, and online product images may vary from images shown here. Not responsible for typographical errors.